



The Petrol Engine Cylinder Block Reinvented: Cast Iron with the same weight as Aluminium

Based on a paper presented at the 43rd International Vienna Motor Symposium, 28 April 2022

Dr Carlos S Cabezas, MSc Cassio L F de Andrade, MSc Jeferson Alexandre
Brzostek, Dr Luis C Guedes, Dr Wilson L Guesser[†], Dr Ralf Marquard[‡]
Tupy Fundições, Brazil ([†]In memoriam, [‡]Consultant)

Mike Jeremy, Eduard Zents, Ricardo Ltd, United Kingdom

Dr Steve Dawson, SinterCast AB, Sweden

Abstract

Compacted (Vermicular) Graphite Iron (CGI, GJV) has become the default material for V-diesel passenger vehicle cylinder blocks and for heavy-duty cylinder blocks and heads. However, there has not yet been a high-volume series production reference for CGI in small, in-line petrol engines. In order to demonstrate the potential benefits of CGI for in-line petrol applications, the present study converted the cylinder block of a state-of-the-art series production 1.2 litre three-cylinder engine from aluminium to CGI. The revised engine was simultaneously upgraded to a 48-Volt hybrid configuration to further demonstrate the potential of CGI in hybrid and range-extender applications.

Leveraging a novel design concept, with the running surface and load path constructed from high-strength CGI and the outer crankcase housing fabricated from durable, lightweight plastic, the assembled cylinder block achieved the same weight as the original aluminium block. However, it is noted that the design of the CGI cylinder block was constrained by the need to maintain outer dimensions and bore-centres to facilitate engine assembly for durability testing. It is estimated that a clean-sheet design approach would have enabled a further 5% reduction in the weight of the CGI cylinder block.

NVH modal analyses showed that the global flexural modes of the CGI cylinder block were approximately 5% higher than original aluminium block while the four main bearing cap modes were 18~40% higher, indicating potential NVH advantages for the CGI engine. The CGI cylinder block successfully passed 100-hour durability, including testing at peak load. With weight parity – and the inherent advantages of cast iron for mechanical properties, parent bore running surfaces, fracture split main bearings, cost, recyclability and lower life cycle CO₂ – Compacted Graphite Iron has established a new benchmark for small, in-line passenger vehicle petrol engines.

Introduction

Although Compacted (Vermicular) Graphite Iron (CGI) was first observed and patented in 1948, the first series production CGI engine wasn't launched until 1999. The nearly 50-year development cycle, from innovation to implementation, was primarily due to the narrow stable range for the reliable series production of high quality CGI.

With the advent of modern foundry measurement and process control technology, CGI has become a standard production material. Current production is more than two million CGI engines per year, with high-volume passenger vehicle references for CGI cylinder blocks in V-type and in-line diesel engines, and in V-type petrol engines. In commercial vehicle applications, CGI has effectively become the default material for heavy-duty cylinder blocks and cylinder heads. CGI is also used in passenger vehicle exhaust manifolds and turbocharger housings and in a variety of off-road and industrial power applications, resulting in a current range of CGI series production engine components spanning from approximately 5 kg to more than 10,000 kg.

Tupy, the world's largest cast iron foundry group, with foundries in Brazil, Mexico and Portugal, has been a pioneer in the development and growth of CGI. With more than 20 years of CGI product development, series production and machining experience, Tupy has established itself as the highest volume manufacturer of CGI with more than 20 engine components currently in production, accounting for more than 125,000 tonnes per year of shipped CGI castings.

While Tupy has motivated and supported the rapid growth of CGI in passenger vehicle and heavy-duty applications, there has not yet been a high-volume application of CGI for small in-line petrol engines. Therefore, in order to demonstrate the potential benefits of CGI in this highest-volume sector, Tupy collaborated with Ricardo and SinterCast – the global leader for CGI process control technology – to convert the cylinder block of a modern state-of-the-art three-cylinder petrol engine from aluminium to Compacted Graphite Iron. The revised engine was simultaneously upgraded to a 48-Volt hybrid configuration to further demonstrate the potential of CGI in hybrid and range-extender applications.

With a novel design approach, incorporating durable plastic covers for the lower crankcase and oil sump, the re-imagined CGI-version of the 1.2 litre three-cylinder engine provided the same total engine weight and the same performance (92 kW and 180 Nm) as the series production aluminium engine. The project culminated with the successful running of a 100-hour dynamometer durability test. The introduction of the CGI cylinder block also provided all of the well-established benefits of cast iron, including superior mechanical properties, parent bore running surfaces, fracture-split main bearings, reduced cost, recyclability and reduced life-cycle CO₂ emissions.

Cylinder Block Design

Over the past thirty years, the minimum wall thickness in cast iron cylinder blocks has progressively decreased from 4.5 mm (+1.5 mm / -1.0 mm) produced in green sand moulds to the current series level of 3.0 mm (+/- 1.0 mm) produced in fully enclosed core packages. The present study took a further step forward, establishing 2.7 mm as the nominal wall thickness (+/- 0.8 mm). While it is possible to make further reductions, the present study acknowledged that the benefit gained by further reducing all of the minimum walls from 2.7 mm to 2.5 mm is one of diminishing returns – the task is challenging and the weight reduction is marginal. Instead, the present study introduces a creative new approach to achieve the next quantum step in weight reduction. First, the overall architecture was re-imagined, incorporating low-density plastic covers for the lower crankcase housing and oil sump; and second, Compacted Graphite Iron grade GJV 550 was introduced to enable substantial reductions in the thickness of the heaviest load bearing sections of the block.

The reference engine for the present study was a state-of-the-art 1.2 litre in-line three-cylinder petrol engine, launched in 2016, based on an aluminium cylinder block. The objective was to convert the cylinder block from aluminium to CGI while maintaining the performance, the total weight, and thus the power density of the engine. In order to assemble a running engine for durability testing, the outer dimensions and bore centres of the CGI cylinder block were maintained to allow components to be used from the donor engine. The weight of the original aluminium cylinder block, shown in Figure 1, was 14.05 kg (16.59 kg including bearing caps and fasteners). The fully assembled aluminium engine weight is 92.0 kg.



a) 1.2 litre aluminium cylinder block (14.05 kg)



b) Upper oil pan (3.45 kg)

Figure 1: The weight of the aluminium cylinder block assembly, including block, steel bearing caps, upper and lower oil pan and fasteners was 21.06 kg

The high pressure die cast aluminium cylinder block, produced with no internal sand coring, comprised a metal volume of 5,230 cm³. Minimum wall thickness was 4.0 mm and there were several heavy sections throughout the block. For reference, direct material substitution with CGI in the existing aluminium design would result in a weight of approximately 38 kg. The first design analysis, based on conventional lightweighting techniques, showed that the maximum possible reduction of wall thicknesses in the existing architecture could lead to a CGI block weight of approximately 30 kg; still an increase of 40-45% relative to the aluminium engine. It was clear that a completely new design approach was needed. The task therefore began to identify and eliminate all unnecessary mass and to modify the architecture to apply plastic casings for the lower crankcase housing and the oil sump.

The first CGI design variant was developed with the use of OptiStruct® software with the cylinder block being subjected to eight different load conditions, including firing, bending and torsional loading. The block design was iteratively modified to produce an architecture that provided the same stiffness as the original aluminium block, with a minimum volume of material.

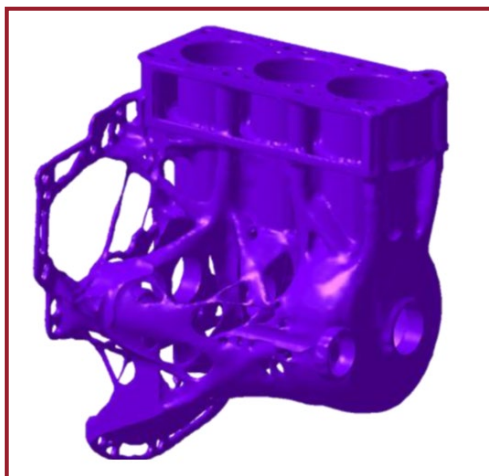

a) Initial OptiStruct concept with closed bedplate

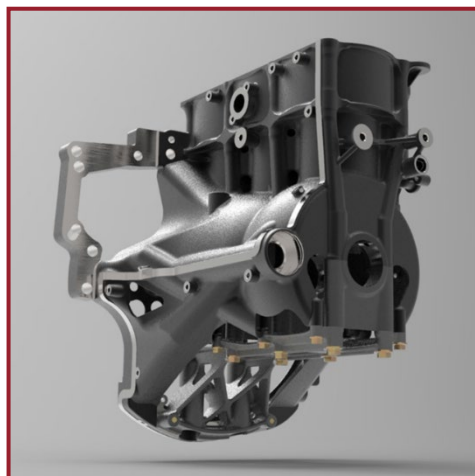

b) Final concept after design-for-manufacture review

Figure 2: Evolution of the CGI cylinder block from the initial OptiStruct concept with closed bedplate to a production-ready design with fracture split main bearings and a CGI ladderframe

The resultant design is shown in Figure 2 (a). The initial OptiStruct design was analysed for bore distortion and ring conformability, head mounting stresses and local stress concentrations, together with CFD analyses to predict peak temperatures in the cylinder bore walls. Regions with low safety factors were modified by altering contours, section thicknesses and fillet radii to approach the safety factors and stiffness profiles of the original aluminium block. The final design of the CGI cylinder block, together with fracture split main bearings and CGI ladderframe is shown in Figure 2 (b). Nominal wall thickness for both the cylinder block and the ladderframe was 2.7 mm +/- 0.8.

Over the eight load cases investigated, the final CGI design provided 92% of the stiffness of the original aluminium block, and 96% for the six most dominant load cases. Likewise, as shown in Figure 3, cylinder bore distortion was similar to the original aluminium engine and satisfied ring conformability with 1 µm oil film. The minimum bore wall thickness in the inter-bore area adjacent to the cored water cooling passage was set at 2.0 mm, which is consistent with the wall thickness applied in a high volume CGI petrol engine manufactured by Tupy. Bore wall temperatures displayed a normal profile with typical temperatures of approximately 200°C and peak temperatures remaining below 230°C.

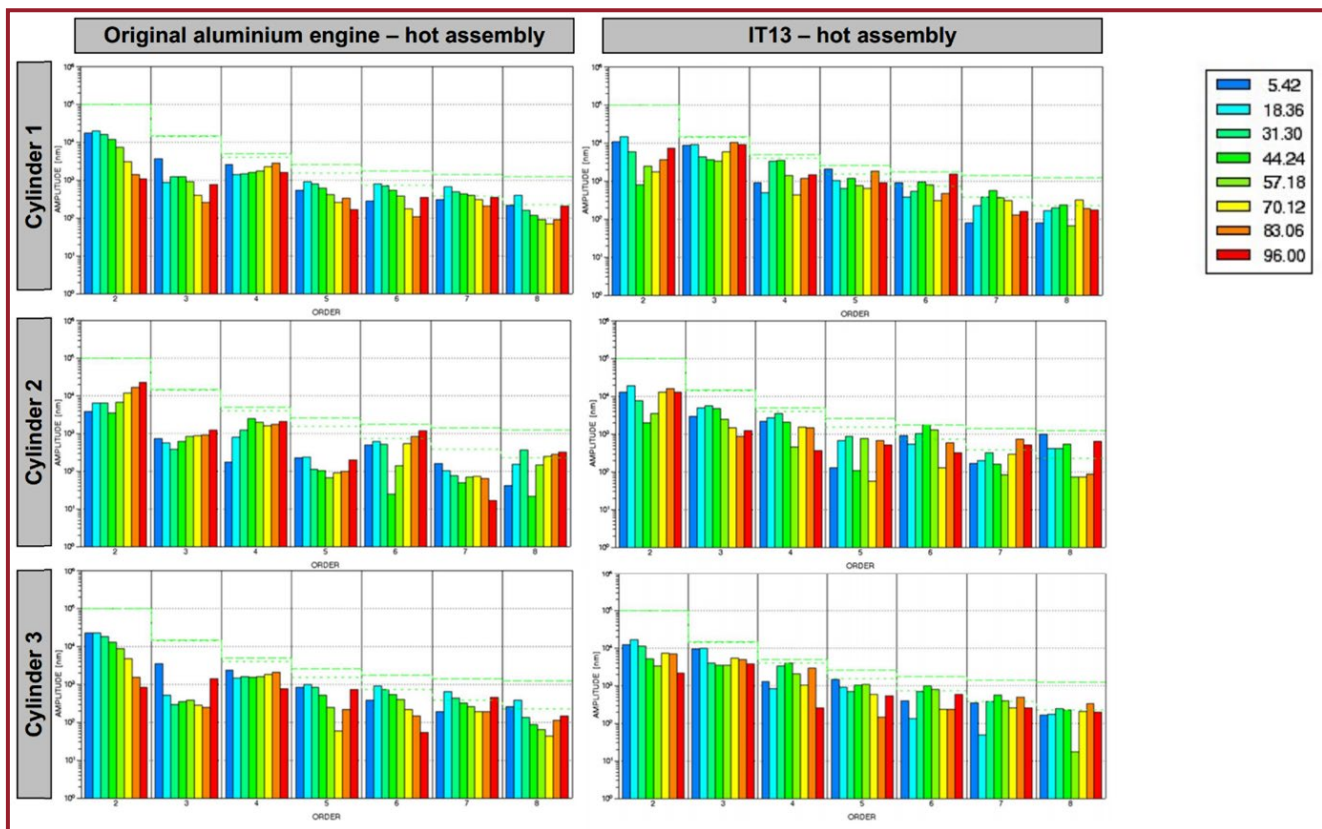

a) Aluminium – hot assembly

b) CGI – hot assembly

Figure 3: Cylinder bore distortion in the original aluminium engine and in the CGI engine; both concepts satisfy piston ring conformability with 1 μm oil film (nm)

The use of CGI for the cylinder block enabled the adoption of fracture split main bearings. The fracture split CGI bearings had a narrower profile than the steel bearing caps used in the original aluminium block assembly, further contributing to the overall weight reduction. Unique to CGI, fracture splitting improves the roundness of each individual bearing, reduces lateral movement, and improves bearing cylindricity after engine assembly. In contrast, grey iron cylinder blocks are not suitable for fracture split bearings due to sub-surface crack formation resulting in relative movement between the bearings and the caps during engine operation, ultimately leading to poor engine performance and possibly catastrophic engine stoppage. Further, the use of grey iron in this application would not have provided the strength and durability needed to achieve weight parity with the aluminium engine. While ductile iron would be suitable for the fracture split main bearings, the strong tendencies of ductile iron to incur shrinkage porosity and other casting defects preclude its application to complex components such as automotive cylinder blocks. Most current CGI cylinder block applications use Grade GJV 450, providing a minimum tensile strength of 450 MPa. A new Grade – GJV 550 – was developed and applied for the current project, providing more than 20% increase in mechanical properties.

The weight reduction offered by the CGI cylinder block concept was augmented by the novel use of durable plastic casings that enclosed the lower crankcase and also served as the oil sump. The casings were fabricated from PA66GF30 plastic with a density of 1,690 kg/m³, and were designed to incorporate the oil galleries, the oil cooler mount, the timing case and the lower oil pan. The use of low-density plastic casings provides a significant weight reduction contribution to the CGI design where the parent metal density is approximately 7,150 kg/m³ but does not confer any significant benefit in aluminium designs where the substitution of metal by plastic would require thicker wall sections for bottom-end durability and where the parent metal density is approximately 2,700 kg/m³. The ladderframe was initially considered in both CGI and aluminium versions, however, the aluminium version resulted in increased bearing distortion due to thermal expansion differences. For this reason, combined with durability considerations, the engine was developed with a CGI ladderframe.

The nominal FE design weight of the of the cylinder block including the ladderframe and fasteners was 17.72 kg (20.06 kg including 2.34 kg for the plastic casings, gaskets and fasteners). The thread engagement depth for the bolts used in the CGI block was 1.2 times diameter (1.7 times diameter in the original aluminium block) resulting in shorter bosses and an

incremental contribution to the weight reduction. The mounting flange on the fully machined CGI block and the assembled outer plastic casings are shown in Figure 4. The more open CGI design concept also provided dramatic decreases in metal volume and therefore, increases in breathing area relative to the original aluminium block. The total metal volume decreased by 54%, from 5,230 cm³ in the aluminium block to 2,388 cm³ in the CGI block. The breathing area, measured as the average between main bearing 1-2 and main bearing 2-3, increased by a factor of 2.25, from 5,145 mm² in the original aluminium block to 11,580 mm² in the redesigned CGI block.

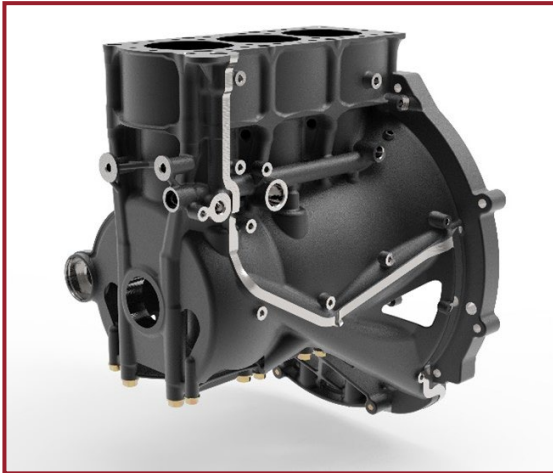

a) Machined CGI block with mounting flange for plastic outer casing

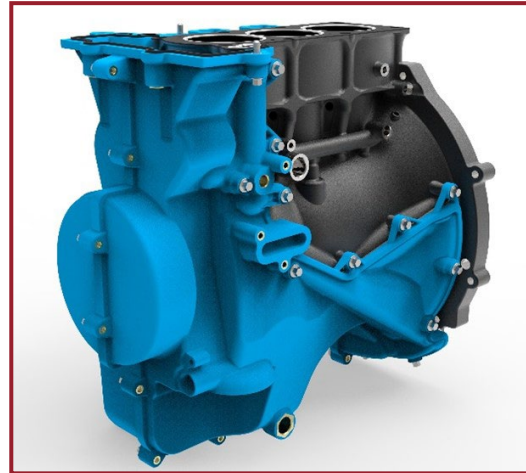

b) CGI cylinder block assembly with outer plastic casings

Figure 4: The FE design weight for the CGI cylinder block assembly, including block, fracture split caps, ladderframe, outer casings, gaskets and fasteners was 20.06 kg

In the 48-Volt hybrid configuration, the water pump and the air conditioner compressor were removed from the block and driven by the battery while the alternator and the belt tensioner were not required. However, the concept could also be applied to a conventional internal combustion engine configuration, with outer casings only on the sides of the cylinder block, potentially incorporating the water pump. As shown in Figure 5, the removal of the water pump other ancillaries results in the elimination of the integrated water pump housing and four bosses from the original block. The elimination of these features results in a weight reduction of 590 grams from the aluminium block, reducing the weight from 14.05 kg to 13.46 kg.

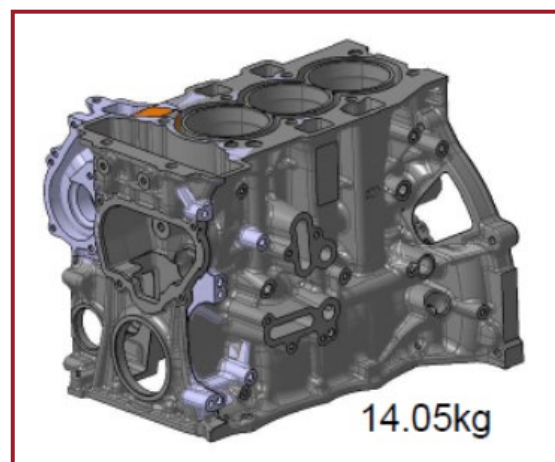

Figure 5: The removal of the integrated water pump housing and five bosses in the 48-Volt configuration reduces the aluminium cylinder block weight from 14.05 kg to 13.46 kg, resulting in a reduction of the assembled block weight from 21.06 to 20.47 kg including the bearing caps, upper and lower oil pan and fasteners

The final consolidation of weights for the different cylinder block configurations is summarised in Table I. The use of CGI, together with the novel hybrid iron-plus-plastic design concept provided weight parity for the cylinder block assembly, and therefore for the fully assembled engine.

Component	Aluminium (Original)	Aluminium (48-Volt)	CGI (48-Volt)
Cylinder Block*	14.05	13.46	15.68
Bearing Caps and Fasteners	2.54	2.54	--
Ladderframe and Fasteners	--	--	2.04
Outer Casings (Including Rear Cover, Gaskets and Fasteners)	--	--	2.34
Upper Oil Pan and Fasteners	3.45	3.45	--
Lower Oil Pan and Fasteners	1.02	1.02	--
Total Cylinder Block Weight	21.06	20.47	20.06
Assembled Engine Weight (Dry)	92.0		91.0

*Note: The CGI cylinder block weight includes the fracture-split caps

Table I: Summary of cylinder block and fully assembled engine weights (kg)

Overall, the design of the CGI cylinder block was constrained by the fixed dimensions of the existing aluminium block, including the outer dimensions and the bore pitch, in order to assemble a running CGI engine. The initial design analysis indicates that a clean-sheet design could have provided a further 5% weight reduction for the CGI concept, together with commensurate reductions in package size. Alternatively, if the original block weight was maintained, increases in power density could have been realised, demonstrating the potential application of the lightweight CGI concept in hybrid and range extender applications.

NVH Modal Analysis

As an integral part of the comparison between the new CGI design concept and the original aluminium benchmark engine, comprehensive modal analysis testing was conducted on the cylinder block and on each of the individual main bearings. As shown in Figure 6, the analysis was conducted by suspending the block assemblies on bungee cables in a free-free condition ensuring a bounce mode of less than 8 Hz. The excitation was provided by two calibrated shakers, with the shaker locations selected based on a series of driving point inertance measurements to identify clear resonant peaks. The bearings caps, ladderframe and oil pans were fitted for the block testing although oil seals and ancillary brackets were removed.

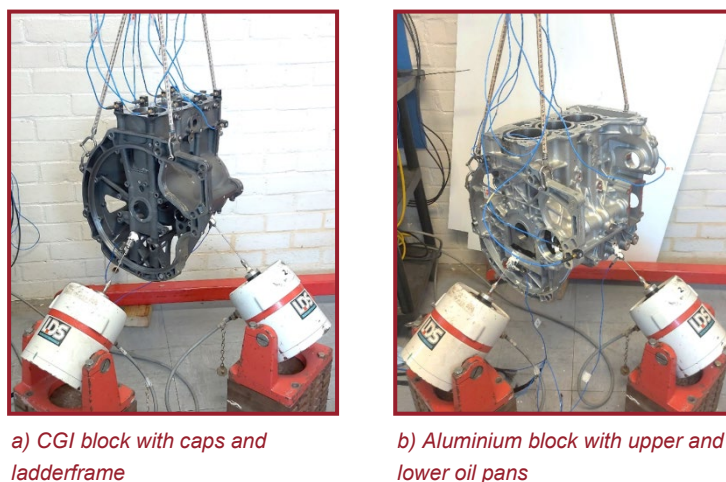

Figure 6: Experimental set-up for the NVH testing showing excitation shaker points on the flywheel end and on the lower side of the block, near the midpoint

Owing to the significant differences in the block architectures, different modal frequency peaks appeared in the two engine assemblies. The nearest major modes are compared in Table II, showing that the global flexural modes of the CGI cylinder block assembly are approximately 5% higher than the original aluminium engine, providing indications of a positive contribution to engine NHV. This 5% increase in the principal resonance frequencies is due to the combined effects of the block architecture and the fact that the elastic modulus (material stiffness) of CGI is approximately double that of the aluminium alloys used for cylinder blocks. The modal analysis simultaneously showed that the resonance of the local mode for the starter arm was approximately 20% higher in the benchmark engine, indicating that a bespoke design of the CGI engine could address the design in the starter arm area to improve stiffness.

Mode Description	CGI (Hz)	Aluminium (Hz)	CGI Increase
Block Torsion	952	908	4.8%
Torsion – Bell Housing Lower	978	939	4.2%
Local Mode – Starter Arm	677	844	-19.8%

Table II: Comparison of major modes in the CGI and aluminium cylinder block assemblies

Following the cylinder block tests, each of the four individual main bearing caps was subjected to a modal impact test. The bearing cap measurements were conducted in a similar free-free test configuration, without the shakers attached. The excitation force was provided by a calibrated nylon tip hammer with a single accelerometer to measure the response from each hammer impact. The results provided in Table III represent the average of the modal response from ten hammer impacts.

Mode Description	CGI (Hz)	Aluminium (Hz)	CGI Increase
Bearing Cap 1 – Front End	1,969	1,398	40.8%
Bearing Cap 2	1,967	1,347	46.0%
Bearing Cap 3	1,763	1,346	31.0%
Bearing Cap 4 – Flywheel End	1,441	1,222	17.9%

Table III: Comparison of bearing cap modes in the CGI and aluminium cylinder block assemblies

Table III shows that the bearing cap main frequency modes are 200 to 600 Hz (18 to 46%) higher than the benchmark, indicating a significant increase in the stiffness of the bearing caps, despite the thinner profile and reduced weight of the fracture split CGI caps. This improved stiffness is due to the combined effect of the unique ability of CGI to employ fracture split main bearings, and the adoption of the CGI ladderframe.

Proof of Concept Durability Testing

The project concluded with a 100 hour dynamometer test to validate the durability of the design concept. The test was divided into six segments including a four hour break-in period with engine speeds ranging from 1,250 to 5,000 rpm; four segments of 20~25 hours at progressively increasing load levels; and, a four-hour segment at full load of 5,000 rpm and 180 Nm of torque. Regular borescope inspections and performance checks were conducted during the initial break-in period to ensure proper mating and bedding-in of pistons, rings and bore surfaces. Thereafter, borescope inspections were conducted every ten hours and the engine oil was changed at the 50-hour interval, according to standard test procedures. The test cycle is summarised in Table IV while the test bed is shown in Figure 7.

Parameter	Step 1	Step 2	Step 3	Step 4	Step 5
Engine rpm*	2,000-3,000	3,000-4,000	3,000-4,000	4,000-3,000	5,000
Torque (Nm)	90	120-110	140-130	160-175	179.5
Power (kW)	18.9	37.7-46.1	44.0-54.5	67-55	94
BMEP (bar)	9.5	12.6-11.6	14.7-13.7	16.8-18.4	18.8
Time (hrs)	21	25	25	21	4

*Note: Engine rpm cycled every 30 minutes in Steps 1 through 4

Table IV: Proof of concept durability test cycle following the four-hour break-in period

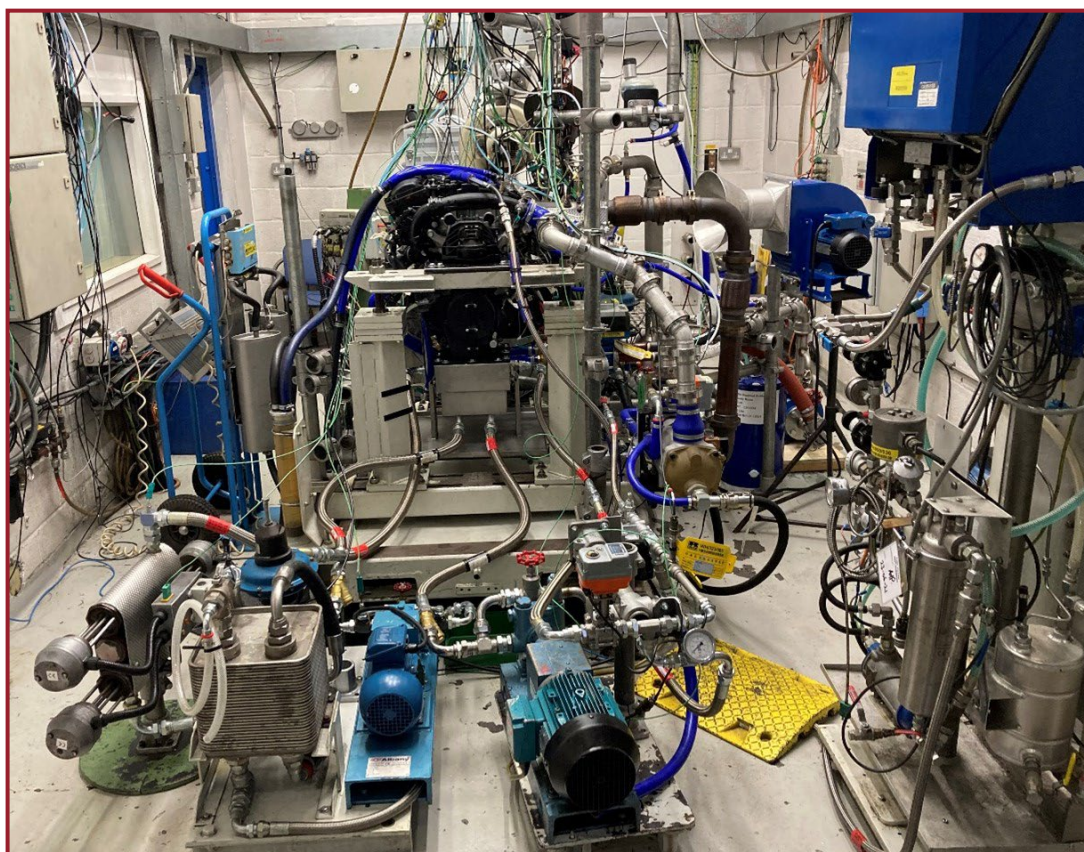

Figure 7: Configuration of dynamometer cell, with external oil and coolant pumps

The dynamometer test successfully validated the mechanical viability of the concept. The fuel consumption (25.8 kg/hr) and blowby (66-74 L/min) under 5,000 rpm full load conditions, and the Friction Mean Effective Pressure (0.25 bar) at 2,000 rpm, were all within the normal range of the aluminium series production engine. All of the major components demonstrated solid durability with no evidence of deformation or cracking in the cylinder block or in the fracture split main bearings. Likewise, there was no evidence of blowby leakage around the cylinder head gasket, and the piston crowns and under-crown positions were in good condition upon visual inspection at the conclusion of the test. The piston rings were also in good condition at the

conclusion of the test with piston ring gaps ranging from 0.23 to 0.28 mm, well-within the Ricardo top ring specification of 0.15-0.30 mm. The final bore roundness was similar to that measured before the start of the test and, as shown in Table V, was generally within the Ricardo guideline of 10 μm at the conclusion of the test.

Below Top Deck (mm)	Cylinder 1 (μm)	Cylinder 2 (μm)	Cylinder 3 (μm)
10	7.8	14.9	7.2
20	7.8	13.1	6.6
49	4.7	6.4	5.2
106	8.5	9.3	9.0

Table V: Cylinder bore roundness at the conclusion of the 100-hour engine test (with headplate)

Beyond the major engine components, the outer plastic casing also proved to be durable during the proof of concept test. The inner and outer surfaces of the left-side plastic casings, at the conclusion of the engine test, are shown in Figure 8.



Figure 8: Inner and outer surfaces of the left-side plastic casings at the conclusion of the 100-hour engine test

As the first running engine test for this new design concept, the durability test also served to identify opportunities to improve the design concept. The first observation was that, for this limited test, it was necessary to use the piston skirts and ring land shape that were initially optimised to match the behaviour of the aluminium donor engine. This resulted in some scuffing on the thrust side of the CGI cylinder bores.

The scuff locations corresponded to the position of cored cooling water passages and reinforcing ribs on the outer surface of the cylinder block. Together, these features in the block – and the piston geometry – could be optimised to ensure matching between the CGI bores and the pistons to eliminate the scuffing (it is noted that the original aluminium block does not have interbore cooling). The second observation identified potential enhancements in the outer plastic covers, where the robustness of the fixtures for the coolant transfer spigots could be enhanced, possibly by through-bolting rather than threaded inserts in the plastic shell. Finally, in the 48-Volt configuration, where the plastic casings wrap around the front of the block, future iterations will incorporate a window in the casing to allow access to the timing belt tensioner.

Foundry and Machining

Upon receipt of the structural design, MAGMASOFT® simulations were conducted to establish and optimise the mould filling. The primary objectives for the casting process were to avoid carbides in the thin outer walls; to avoid turbulence that could lead to casting defects or cold shuts; and, to minimise residual stresses, particularly at the junction of thick and thin walls at the bottom end of the block. The simulations led to a gating system that fed the iron directly into the main bearings to maximise the heat flow into the cylinder bore walls. Additional mass was also added above the machined top deck level to increase the metal flow-through, ensuring low-nodularity CGI microstructures in the thermally loaded cylinder bores. Higher liquid metal temperatures were also directed to the thin outer regions and the rear gearbox flange to minimise carbide formation. Figure 9 shows the simulated metal flow velocity and the temperature profile.

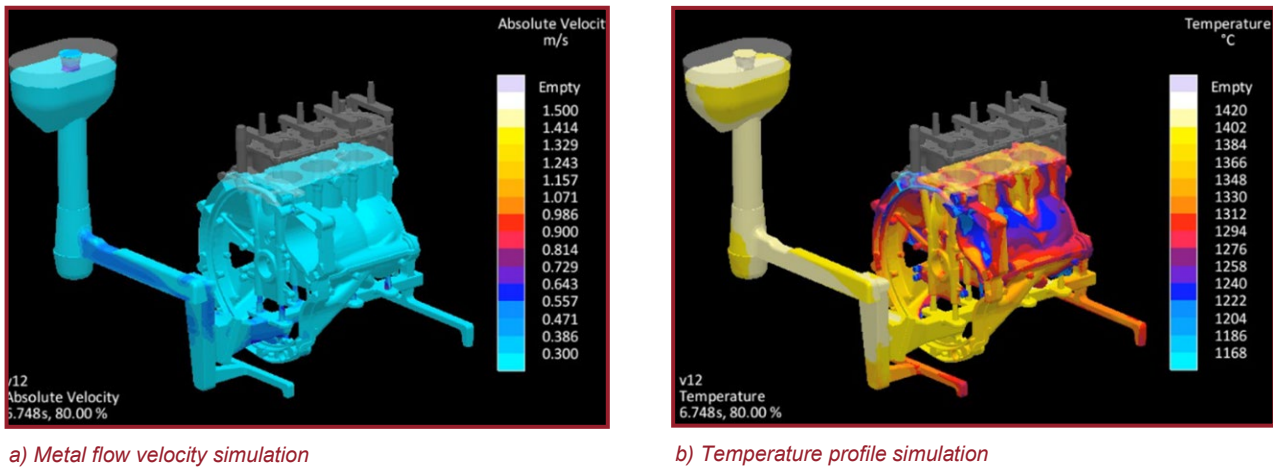

Figure 9: The gating system provides uniform velocity, with no turbulence, and higher temperature in thinner areas to avoid carbide formation and cold shuts

Following the first prototype casting trials, additional mass was added to some sections of the tooling to optimise castability. As shown in Figure 10 (a), the main addition was to the top deck to ensure controlled cooling of the cylinder bore walls. This additional mass was removed during machining, resulting in no increase in the weight of the finished cylinder block assembly. Some additional material was also added to machined bosses, the mounting flanges for the plastic casings, and to the rear gearbox flange. Again, the majority of this material was removed during machining. The simulations also showed the need to increase several fillet radii and the thickness of some ribs to alleviate residual stresses. Together, these changes resulted in a weight increase of approximately 500 grams compared to the original FE design, maintaining weight parity with the original aluminium block. The dimensional analysis of the as-cast block and ladderframe, shown in Figure 10, show that the main structural areas of the block are within the casting tolerance of ± 0.8 mm.

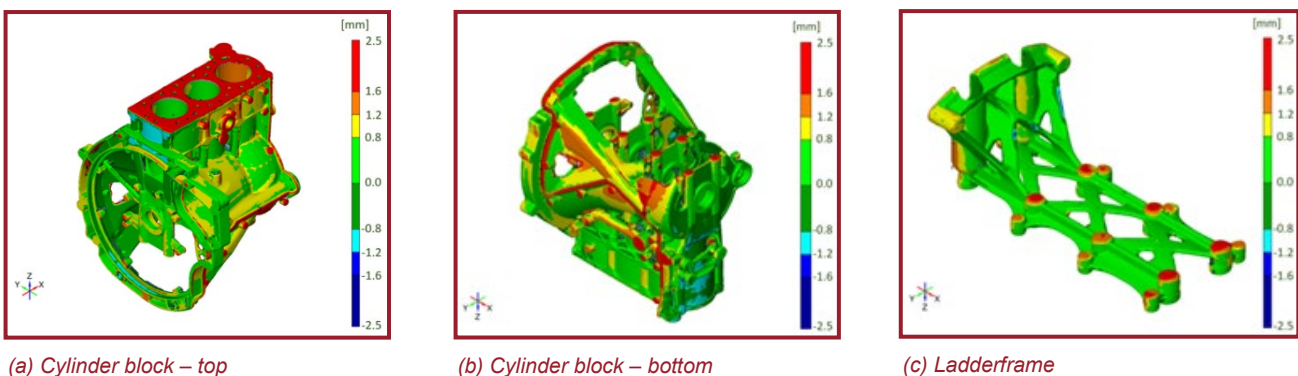
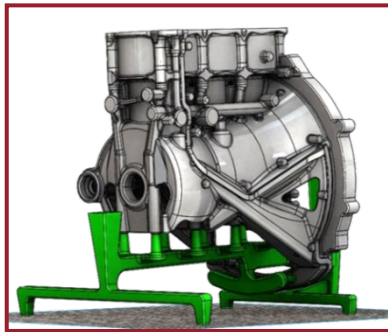
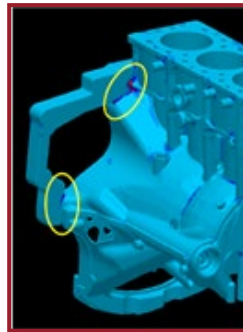

Figure 10: Dimensional analysis of the cylinder block and ladder frame, showing all load-bearing areas within dimensional tolerance

The cylinder block and ladderframe castings were produced by additive manufacturing of individual cores that were assembled to form fully enclosed core packages. The fully assembled core packages, with metal filters and running systems incorporated directly in the core packages, were placed into green sand flasks on the standard production line. The sand cores used conventional silica sand and resin compositions while Cerabeads® ceramic sand with increased resin content was used to ensure the robustness of the 2.0 mm thick (25 mm tall) interbore water jacket core. Following the coating process, the interbore water passage was 2.5 mm thick. As shown in Figure 11, the gating system included stabilising bars at either end of the casting minimise residual stress and to protect the rear flange during shake-out.



a) Stabilising bars at either end of the casting



b) Residual stress concentration in original design

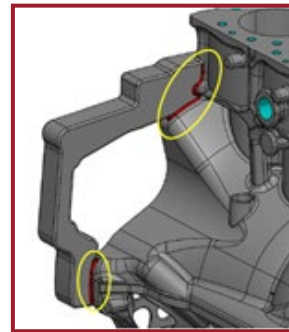

c) Increased fillet radii to minimise residual stress

Figure 11: Make-like-production tooling, with stabilising bars at either end of the casting and increased fillet radii, reduced casting stress and protected the rear gearbox flange during shake-out

The moulds were poured with series production iron, prepared in 14-tonne medium frequency induction furnaces and poured from 1,500 kg ladles on the standard series production moulding line at the Tupy foundry in Saltillo, Mexico. The liquid metal was controlled by the SinterCast process control technology, using thermal analysis parameter settings developed by Tupy to achieve the desired low-nodularity in the thermally loaded cylinder bores, together with higher nodularity in the main bearings and outer walls to maximise strength, NVH and durability. The core packages and as-cast castings are shown in Figure 12.

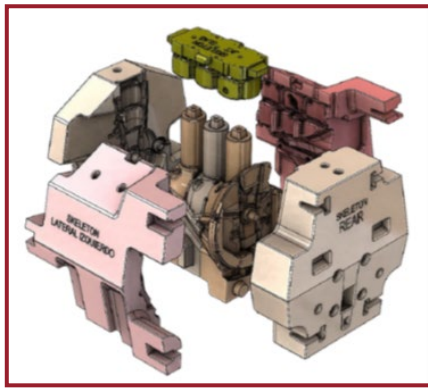

a) Exploded view of the cylinder block core package



b) Assembled core package with four ladderframes set into standard series production green sand flask

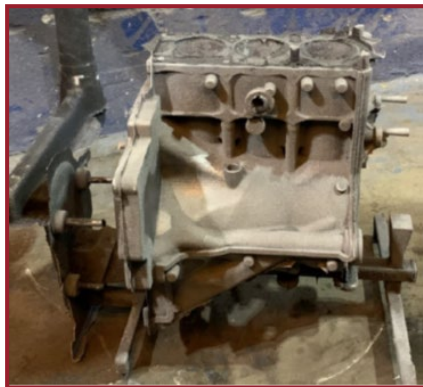

c) as-cast cylinder block with gating system and stabilising bars



d) Ladderframe castings after shotblasting

Figure 12: The cylinder blocks and ladderframes were produced in 3D printed core packages on the standard series production line using series production iron

The as-cast cylinder blocks and ladderframes were subjected to magnetic particle testing before and after shotblasting to ensure that all castings were sound. In total, twelve sets of castings were produced to provide set-up blocks for machining, machined components for NVH modal testing and engine assembly for the 100-hour durability test and, display castings.

The machining of the cylinder blocks and ladderframes was conducted by Grainger & Worrall in the UK. In advance of the machining, Tupy, Ricardo and Grainger & Worrall simulated the machining operations to establish feasible machining paths and to confirm tolerances, based on CGI series production experience at Tupy. The finished castings were machined using conventional carbide inserts and standard cutting feeds and speeds established for series production CGI castings, with no manufacturing concerns, despite the improved properties of the GJV 550 grade. The main bearings were fracture split at Alfin in Germany using bespoke tooling in standard series production equipment. The cylinder blocks used for engine assembly were plateau honed to the same specification as the cast iron inserts used in the aluminium donor engine. The block used for NVH modal analysis was unhone.

Material Properties

In comparison to aluminium alloys used for high-pressure die casting of cylinder blocks, Compacted Graphite Iron provides more than double the fatigue strength, double the elastic modulus (stiffness), and approximately 75% higher tensile strength. In comparison to conventional grey cast iron, CGI provides approximately 75% higher strength, 50% higher stiffness and double the fatigue strength. These superior mechanical properties provide the basis for weight and size reduction, improved engine durability and, in new applications, increased performance.

The international ISO 16112 standard for Compacted Graphite Iron specifies six grades of CGI ranging from 300 MPa to 500 MPa, increasing in increments of 50 MPa. In order to maximise the weight reduction potential, the present study leveraged the high cooling rate in the thin walls of the cylinder block and ladderframe to achieve ultimate tensile strengths of more than

550 MPa in the main bearings and more than 600 MPa in the 2.7 mm nominal outer walls of the block. By strategically modifying the mould filling and gating, the overall objective was to ensure slow cooling of the cylinder bore walls to ensure low nodularity (for efficient heat transfer and good machinability), while exploiting the rapid cooling in the outer sections of the block to maximise strength and stiffness.

As shown in Figure 13, the microstructure in the thermally loaded cylinder bore walls contained approximately 10% nodularity with more than 90% pearlite, as evaluated by Image Pro-Plus image analysis software using the nodularity evaluation guidelines in the ISO 16112 standard. This structure provides the optimum combination of thermal conductivity for efficient heat transfer, together with strength, stiffness and Brinell hardness for bore dimensional integrity and tribology. The nodularity values in Figure 13 (a) were obtained from the as-cast block, such that the uppermost value of 18% nodularity represents the top deck of the block after machining. The bore microstructure satisfies all OEM Specifications for CGI cylinder blocks currently in series production.

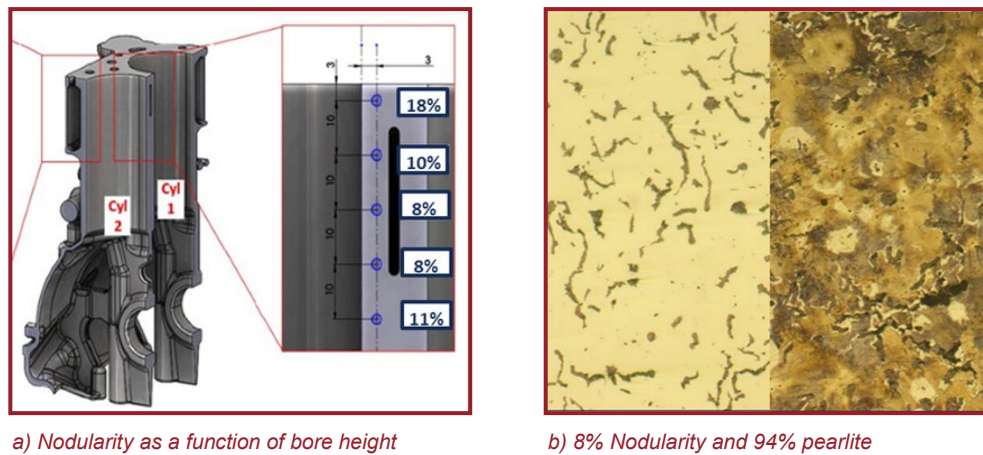

Figure 13: The nodularity in the cylinder bore walls conforms to current OEM Specifications for CGI, providing thermal efficiency, dimensional integrity and wear resistance

In conventional grey cast iron, thin (<4 mm) walls frequently develop degenerated (D-type) graphite that leads to a reduction in strength. However, with CGI, fast-cooling sections solidify with higher nodularity resulting in increased strength, stiffness and ductility. The ultimate result is that the tensile strength in the thin walls of conventional grey cast iron can decrease below 250 MPa while the tensile strength of CGI can increase beyond 600 MPa. The design of the cylinder block and the gating system were developed to exploit this natural cooling rate phenomenon. Figure 14 shows that the nodularity in the fracture split region of the main bearing was approximately 30-35%. Test bars prepared from the main bearings, according to the ASTM E8/E8M standard, provided tensile strengths between 550 and 600 MPa.

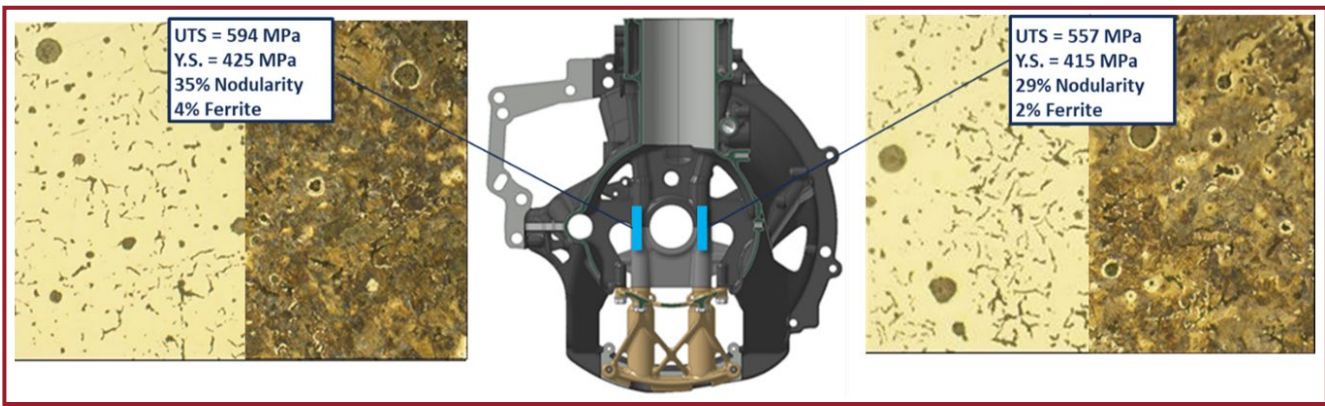
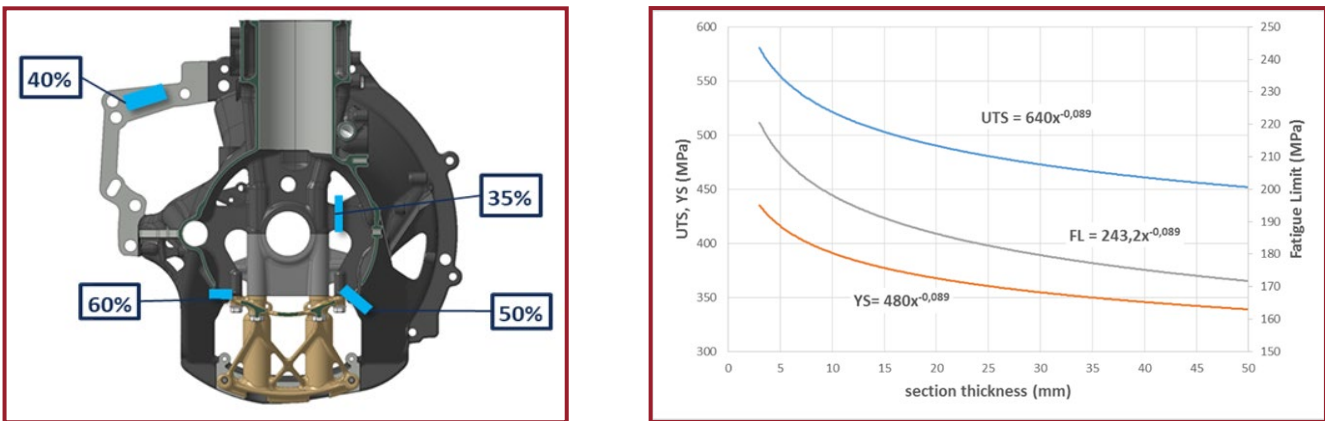

Figure 14: The tensile strength in the fracture-split main bearings exceeded 550 MPa

The cooling rate effect is further illustrated in Figure 15. The nodularity in the thin outer regions of the block, that are not insulated by the thermal mass of the block or by the flow-through effect of the gating system, reached 50-60%. The higher nodularity in these outer walls maximised the strength and stiffness, contributing to the NVH and durability of the engine assembly, ultimately providing the first cylinder block reference for CGI Grade 550. The design properties for the cylinder block and ladderframe, as a function of wall thickness and nodularity, are also summarised in Figure 15.



a) Nodularity in the 2.7 mm nominal outer walls

b) Design properties as a function of wall thickness

Figure 15: The design of the cylinder block and the gating system exploited the cooling rate effect in CGI, providing tensile strengths in excess of 550 MPa

Conclusion

Growing from the first series production engine in 1999 to more than two million engines per year today, Compacted Graphite Iron has been established as a reliable and effective material for passenger vehicle cylinder blocks and for commercial vehicle cylinder blocks and heads. With more than twenty years of CGI product development, foundry production and manufacturing experience, Tupy has applied its CGI knowhow to the retrofit of a 1.2 litre three-cylinder aluminium petrol engine. Relying on thin-wall casting capabilities, with 2.7 mm nominal wall thickness, maximising the reduction of the thickness of the heavier load-bearing sections, and utilising durable low-density plastics for the lower crankcase housing and oil sump, Tupy has presented a 48-Volt hybrid version of the benchmark engine – produced in series production foundry conditions – that provides the same operating performance and the same engine weight.

The re-imagined CGI version of the engine demonstrates the potential for small petrol engines with cast iron cylinder blocks to be weight neutral with aluminium while providing all of the traditional benefits of cast iron, including design flexibility, superior mechanical properties and durability, parent bore running surfaces, fracture split main bearings and reduced cost. Environmentally, CGI cylinder blocks are more recyclable than aluminium and consume less energy than aluminium during the manufacturing phase. From the life cycle perspective, the requirement for aluminium cylinder blocks is that the weight reduction relative to cast iron must provide sufficient reduction in fuel consumption and CO₂ emissions during the life of the vehicle to payback the higher manufacturing energy. However, when the cast iron engine is weight-neutral, the life cycle energy payback for aluminium is meaningless.

The present study demonstrates the widespread operational, economic and environmental benefits of CGI in small, low-cost petrol engine applications. With weight parity and positive NVH contributions, the design philosophy introduced in this paper offers new opportunities for primary drivetrains, hybrid engines and range extenders.

Acknowledgements

The authors would like to express their appreciation and gratitude to Eraldo Cominato for his contributions to the design work, to Heber Espinoza and Luis Fernando de Camargo Guedes for the production of the prototype cylinder blocks and ladderframes; to Joelson Pereira for simulation and evaluation of machining paths and tolerances; to Darren Walters of Grainger & Worrall for his supervision of the machining activities; and to Gary Coles and Jamie Knapp of Ricardo for their overall project management.